



## Selection: Semi-hermetic Reciprocating Compressors

### Input Values

Compressor model	(4TCS-12.2Y)	Suction gas temperature	20,00 °C
Mode	Refrigeration and Air conditioning	Operating mode	Auto
Refrigerant	R404A	Power supply	400V-3-50Hz
Reference temperature	Dew point temp.	Capacity control	100%
Liq. subc. (in condenser)	0 K	Useful superheat	100%

### Result

Q [W]	Cooling capacity	COP [ - ]	COP/EER
Qu* [W]	Evaporator capacity	m [kg/h]	Mass flow
P [kW]	Power input	Op.	Operating mode
I [A]	Current	th [°C]	Discharge gas temp. w/o cooling
Qc [W]	Condenser capacity		

tc	to	0°C	-5°C	-10°C	-15°C	-20°C	-25°C	-30°C	-35°C
30°C	Q [W]	39446	32738	26920	21886	17547	13825	10650	7960
	Qu* [W]	39446	32738	26920	21886	17547	13825	10650	7960
	P [kW]	8,49	8,22	7,81	7,29	6,68	6,00	5,26	4,48
	I [A]	15,04	14,64	14,07	13,36	12,55	11,67	10,78	9,90
	Qc [W]	47940	40954	34729	29179	24230	19825	15910	12442
	COP [ - ]	4,64	3,98	3,45	3,00	2,63	2,30	2,02	1,78
	m [kg/h]	1003	822	670	540	430	337	258	192,1
	Op.	Standard	Standard	Standard	Standard	Standard	Standard	Standard	Standard
	th [°C]	62,1	68,6	75,4	82,6	90,3	98,6	107,8	118,1
40°C	Q [W]	33276	27552	22573	18255	14526	11324	8590	6272
	Qu* [W]	33276	27552	22573	18255	14526	11324	8590	6272
	P [kW]	9,99	9,40	8,72	7,96	7,15	6,29	5,40	4,51
	I [A]	17,23	16,35	15,36	14,28	13,16	12,04	10,95	9,93
	Qc [W]	43262	36949	31289	26216	21673	17613	13994	10781
	COP [ - ]	3,33	2,93	2,59	2,29	2,03	1,80	1,59	1,39
	m [kg/h]	955	780	632	506	400	309	233	169,7
	Op.	Standard	Standard	Standard	Standard	Standard	Standard	Standard	Standard
	th [°C]	73,4	79,8	86,5	93,8	101,5	110,2	119,9	131,4
50°C	Q [W]	27046	22339	18227	14647	11546	8876	6591	4650
	Qu* [W]	27046	22339	18227	14647	11546	8876	6591	4650
	P [kW]	11,17	10,33	9,42	8,45	7,45	6,42	5,39	4,36
	I [A]	19,02	17,74	16,38	14,98	13,57	12,21	10,93	9,77
	Qc [W]	38216	32666	27642	23098	18995	15299	11980	9012
	COP [ - ]	2,42	2,16	1,94	1,73	1,55	1,38	1,22	1,07
	m [kg/h]	901	733	590	469	366	280	206	144,7
	Op.	Standard	Standard	Standard	Standard	Standard	Standard	Standard	Standard
	th [°C]	84,8	91,2	98,0	105,3	113,3	122,3	132,8	0



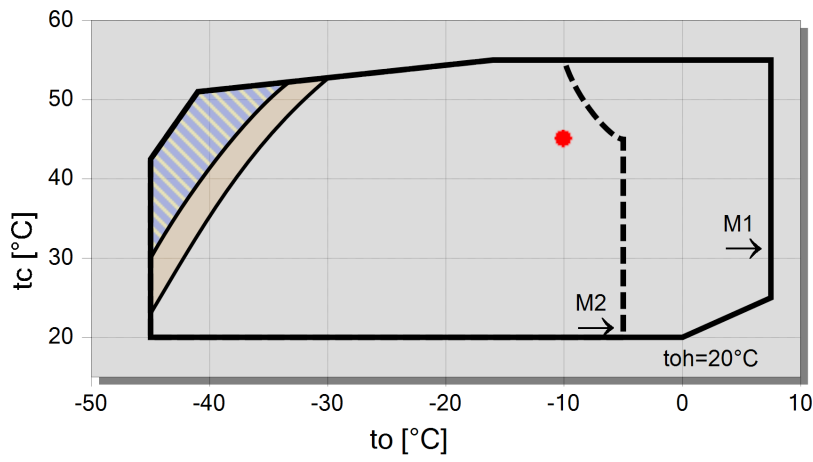

-- No calculation possible (see message in single point selection)

\*According to EN12900 (20°C suction gas temp., 0K liquid subcooling)

## Application Limits 100% 4TCS-12.2



**Legend**

-  additional cooling & suction gas superheat  $\leq 20\text{K}$
-  additional cooling or max. toh  $< 0^\circ\text{C}$
-  M1: motor 1
-  M2: motor 2
-  A



## Technical Data: (4TCS-12.2Y)

### Dimensions and Connections

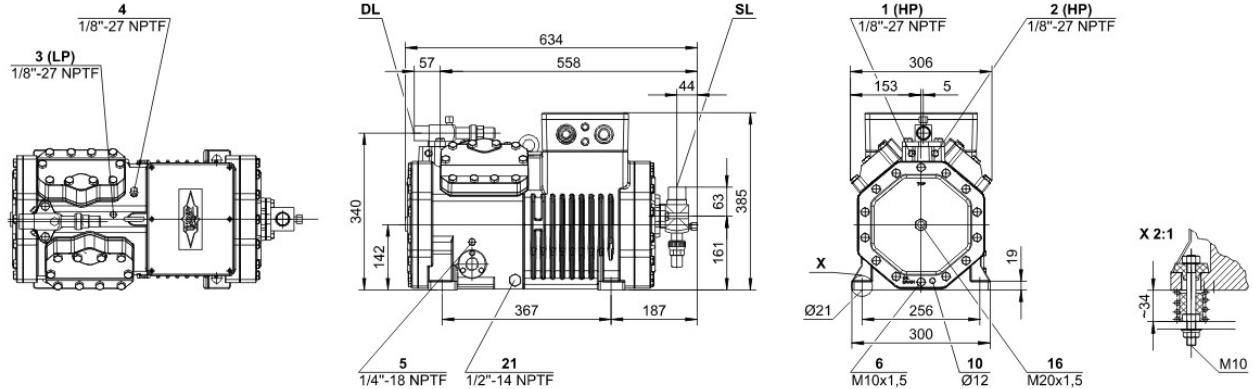

### Technical Data

#### Technical Data

Displacement (1450 RPM 50Hz)	41,33 m <sup>3</sup> /h
Displacement (1750 RPM 60Hz)	49,88 m <sup>3</sup> /h
No. of cylinder x bore x stroke	4 x 60 mm x 42 mm
Weight	141 kg
Max. pressure (LP/HP)	19 / 28 bar
Connection suction line	35 mm - 1 3/8"
Connection discharge line	28 mm - 1 1/8"
Oil type R134a/R407C/R404A/R507A/R407A/R407F	tc<55°C: BSE32   tc>55°C: BSE55 (Option)
Oil type R22 (R12/R502)	B5.2 (Standard)
Oil type R290/R1270	SHC226E (Standard)

#### Motor data

Motor voltage (more on request)	380-420V PW-3-50Hz
Max operating current	24.0 A
Winding ratio	50/50
Starting current (Rotor locked)	69.0 A Y / 113.0 A YY
Max. Power input	13,8 kW

#### Extent of delivery (Standard)

Motor protection	SE-B1
Enclosure class	IP65
Vibration dampers	Standard
Oil charge	2,60 dm <sup>3</sup>

#### Available Options

Connection suction line	Option
Discharge shut-off valve	Option
Discharge gas temperature sensor	Option
Start unloading	Option
Capacity control	100-50% (Option)
Additional fan	Option
Oil service valve	Option
Crankcase heater	0..140 W PTC (Option)
Oil level monitoring	OLC-K1 (Option, not for R290/R1270)

#### Sound measurement

Sound power level (+5°C / 50°C)	73,5 dB(A) @ 50Hz
Sound power level (-10°C / 45°C)	74,5 dB(A) @ 50Hz
Sound power level (-35°C / 40°C)	(79,0) dB(A) @ 50Hz
Sound pressure level @ 1m (+5°C / 50°C)	65,5 dB(A) @ 50Hz
Sound pressure level @ 1m (-10°C / 45°C)	66,5 dB(A) @ 50Hz
Sound pressure level @ 1m (-35°C / 40°C)	(71,0) dB(A) @ 50Hz



## Semi-hermetic Reciprocating Compressors

**Motor 1** = e.g. 4TES-12 with 12"HP", primary for air-conditioning (e.g. R22,R407C) and air-conditioning with R134a at high ambient temperatures.

**Motor 2** = e.g. 4TES-9 with 8"HP", universal Motor for medium and low temperature application (e.g. R404A, R507A, R407A, R407F) and air-conditioning with R134a

**Motor 3** = e.g. 4TES-8, for medium temperature applications and R134a

For more information concerning the application range use the "Limits" button.

### Operation modes 4VES-7 to 6FE-44 and 44JE-30 to 66FE-88 with R407F/R407A/R22

CIC = liquid injection with low temperature application, suction gas cooled motor.

### ASERCOM certified performance data

The Association of European Refrigeration Component Manufacturers has implemented a procedure of certifying performance data. The high standard of these certifications is assured by:

- \* plausibility tests of the data performed by experts.
- \* regular measurements at independent institutes.

These high efforts result in the fact that only a limited number of compressors can be submitted. Due to this not all BITZER compressors are certified until now. Performance data of compressors which fulfil the strict requirements may carry the label "ASERCOM certified". In this software you will find the label at the respective compressors on the right side below the field "result" or in the print out of the performance data. All certified compressors and further information are listed on the homepage of ASERCOM.

### Condensing capacity

The condensing capacity can be calculated with or without heat rejection. This option can be set in the menu Program  Options. The heat rejection is constantly 5% of the power consumption. The condensing capacity is to be found in the line Condensing cap. (with HR) resp. Condensing capacity.

### Data for sound emission

Data based on 50HZ application (IP-units 60Hz) and R404A if not declared.

Sound pressure level: values based on free field area conditions with hemispherical sound emission in 1 meter distance.

### General remarks regarding sound data

Listed sound data were measured under testing conditions in our laboratory. For this purpose the free-standing test sample is mounted on a solid foundation plate and the pipework is connected vibration-free to the largest extend possible. Suction and discharge lines are fixed in a flexible configuration, such that a transmission of vibrations to the environment can be largely excluded. In real installations considerable differences might be observed, compared to the measurements in the laboratory. The airborne sound emitted by the compressor can be reflected from surfaces of the system and this may increase the airborne sound level measured close to the compressor. Vibrations caused by the compressor are also transferred to the system by the compressor feet and piping depending on the damping ratio of the fixings. Thus, the vibrations can induce other components to such an extent that these components contribute to an increase in airborne sound emission. If required, the transfer of vibrations to the system can be minimized by suitable fixing and damping elements.

### Legend of connection positions according to "Dimensions":

- 1 High pressure connection (HP)
- 2 Connection for discharge gas temperature sensor (HP) (for 4VE(S)-6Y .. 4NE(S)-20(Y) connection for CIC sensor as alternative)
- 3 Low pressure connection (LP)
- 4 CIC system: injection nozzle (LP)
- 4b Connection for CIC sensor
- 4c Connection for CIC sensor (MP / operation with liquid subcooler)
- 5 Oil fill plug
- 6 Oil drain
- 7 Oil filter (magnetic screw)
- 8 Oil return (oil separator)
- 8\* Oil return with NH3 and insoluble oil
- 9 Connection for oil and gas equalization (parallel operation)
- 9a Connection for gas equalization (parallel operation)



- 9b Connection for oil equalization (parallel operation)
  - 10 Oil heater connection
  - 11 Oil pressure connection +
  - 12 Oil pressure connection –
  - 13 Cooling water connection
  - 14 Intermediate pressure connection (MP)
  - 15 Liquid injection (operation without liquid subcooler and with thermostatic expansion valve)
  - 16 Connection for oil monitoring (opto-electrical oil monitoring "OLC-K1" or differential oil pressure switch "Delta-PII")
  - 17 Refrigerant inlet at liquid subcooler
  - 18 Refrigerant outlet at liquid subcooler
  - 19 Clamp space
  - 20 Terminal plate
  - 21 Maintenance connection for oil valve
  - 22 Pressure relief valve to the atmosphere (discharge side)
  - 23 Pressure relief valve to the atmosphere (suction side)
  - 24 IQ MODULE
  - SL Suction gas line
  - DL Discharge gas line
- Dimensions can show tolerances according to EN ISO 13920-B.